

NAMIZNI UNIVERZALNI KUHINJSKI STROJ - SUPRA

Univerzalni kuhinjski stroj SUPRA zmore to kar do sedaj ni bilo možno. Primeren je za obdelavo od 30 do 200 obrokov. Obsežen pribor pa omogoča rezanje, ribanje, strganje, pasiranje, rezanje na kocke, mletje mesa in zelenjave, mešanje, stepanje, gnetenje z 10 ali 15 litrsko posodo, mletje maka, mehčanje mesa, rezanje na trakove.

























Univerzalni kuhinjski stroj SUPRA odlikuje:

















- široka uporabnost
- robustna konstrukcija iz visokokakovostnega nerjavečega jekla
- dvojno varnostno stikalo
- dve hitrosti
- zaščitno stikalo za motor
- vgrajeno časovno stikalo
- možna uporaba treh nastavkov: za rezanje zelenjave, za mletje mesa ter stepanje, gnetenje in mešanje testa in smetane
- vrsta toka: 400 V 50 Hz 3 ~N
- moč: 0,55/0,75 kW



















POGONSKI STROJ SUPRA 6e
(tudi v kombinaciji s TIMER-jem)



REZILA Supra 6e

	<p>Rezilna plošča za rezanje zelja, kumaric, čebule, redkve.</p> <p>1,0 mm rez, za cca. 75 kg/h 542815 2,0 mm rez, za cca. 150 kg/h 542816 4,0 mm rez, za cca. 200 kg/h 542817</p>     
	<p>Rezilna plošča za rezanje paradižnika, kuhanega krompirja, pora in čebule.</p> <p>2,5 mm rez, za cca. 100 kg/h 542811 4,0 mm rez, za cca. 150 kg/h 542812</p>    
	<p>Nastavljiv srpasti nož, za fino in grobo rezanje zelja, čebule, kumaric, različnih vrst sadja z rezilom, ki je nastavljivo po 1 mm.</p> <p>0 – 8 mm debelina reza, za 100 – 200 kg/h - z nazobčanim rezilom 542821</p> <p>542820</p>   
	<p>Rezilna plošča za rezanje trakov Za pripravo surovih gomoljev zelenjave, kot so korenje, koleraba, krompir, zelena.</p> <p>2,0 x 2,5 mm za cca. 50 kg/h 542823 3,5 x 3,5 mm za cca. 75 kg/h 542824 5,0 x 5,0 mm za cca. 100 kg/h 542825 5,0 x 7,0 mm za cca. 120 kg/h 542826 7,0 x 7,0 mm za cca. 120 kg/h 542827 7,0 x 10,0 mm za cca. 150 kg/h 542828</p>    
	<p>Plošča za dekorativno rezanje Debelina reza 4,0 mm za rezanje valovitih rezin korenške zelenjave (repa, korenje rdeča pesa, krompir).</p> <p>4,0 mm Schnittstärke Leistung ca. 120 kg/h 542819</p>    

	<p>Strgalna plošča Širina zobnikov 2,0 – 4,0 mm za fino strganje sadja, zelenjave, sira in tršega peciva.</p> <p>2,0 mm zobniki, za cca. 50 kg/h 542832 3,0 mm zobniki, za cca. 75 kg/h 542830 4,0 mm zobniki, za cca. 100 kg/h 542831</p>   
	<p>Rezilna plošča za rezanje sadja in zelenjave za presne solate.</p> <p>2,0 mm zobniki, za cca. 60 kg/h 542833 3,0 mm zobniki, za cca. 100 kg/h 542836 4,0 mm zobniki, za cca. 120 kg/h 542837</p>   
	<p>Rezilna plošča za rezljanje gomoljev kot so kumarice, koleraba, krompir, zelena, itd.</p> <p>6,0 mm zobniki, za cca. 200 kg/h 542838 9,0 mm zobniki, za cca. 220 kg/h 542839</p>   
	<p>Plošča za ribanje krompirja</p> <p>3x3x5 mm kronski zobniki za cca. 100 kg/h 542841</p> 
	<p>Plošča za ribanje surovega krompirja za ribani kolač ali cmoke. 542842</p> 

	<p>Nož za kockasto rezanje s kockasto mrežo, zamaškom, rezilno prečko in vstavkom. 8x8 mm za cca. 150 kg/h 542845 10x10x8 mm za cca. 150 kg/h 542847 16x16x8 mm za cca. 150 kg/h 542849 20x20x8 mm za cca. 150 kg/h 542851</p> <p>Mreža za nož za kockasto rezanje 8 x 8 mm 542846 10 x 10 mm 542848 16 x 16 mm 542850 20 x 20 mm 542852</p>  
	<p>Vstavek za nastavek za pasiranje 1,5 mm velikost odprtine 542860 2,0 mm velikost odprtine 542862 3,0 mm velikost odprtine 542864</p>
	<p>Vstavek za nastavek za ribanje 2,0 mm velikost zobnikov 542867 3,5 mm velikost zobnikov 542869</p>  
	<p>Nož za križno valovito rezanje WAS za rezanje gomoljk kot so kumarice, redkev, krompir. 4,0 mm debelina reza 542858 6,0 mm debelina reza 542859</p>    
	<p>Nož za kockasto rezanje WS, za rezanje majhnih kock za kumarice, redkvice, čebulo, krompir. 2,5 mm dolžina roba (2,5x2,5x2,5) 542872 3,5 mm dolžina roba (3,5x3,5x3,5) 542873 5,0 mm dolžina roba (5,0x5,0x3,5) 542874</p>     

	<p>Priključek za mešanje testa in smetane UP 10 z 10 litrsko posodo 542 805</p> <p>Kapaciteta:</p> <table border="0"> <tr> <td>gosto testo za pico</td> <td>ca. 1,5 kg</td> </tr> <tr> <td>lahko testo</td> <td>ca. 2 kg</td> </tr> <tr> <td>krhko testo</td> <td>ca. 2 kg</td> </tr> <tr> <td>smetana za stepanje</td> <td>ca. 2,5 litra</td> </tr> <tr> <td>sneg iz beljaka</td> <td>ca. 30 beljakov</td> </tr> <tr> <td>krompirjev pire</td> <td>ca. 4 litre</td> </tr> </table>	gosto testo za pico	ca. 1,5 kg	lahko testo	ca. 2 kg	krhko testo	ca. 2 kg	smetana za stepanje	ca. 2,5 litra	sneg iz beljaka	ca. 30 beljakov	krompirjev pire	ca. 4 litre
gosto testo za pico	ca. 1,5 kg												
lahko testo	ca. 2 kg												
krhko testo	ca. 2 kg												
smetana za stepanje	ca. 2,5 litra												
sneg iz beljaka	ca. 30 beljakov												
krompirjev pire	ca. 4 litre												
	<p>Priključek za mešanje testa in smetane UP 15 s 15 litrsko posodo 542 840</p> <p>Kapaciteta:</p> <table border="0"> <tr> <td>gosto testo za pico</td> <td>ca. 4 kg</td> </tr> <tr> <td>lahko testo</td> <td>ca. 5 kg</td> </tr> <tr> <td>krhko testo</td> <td>ca. 5 kg</td> </tr> <tr> <td>smetana za stepanje</td> <td>ca. 6 litrov</td> </tr> <tr> <td>sneg iz beljaka</td> <td>ca. 45 beljakov</td> </tr> <tr> <td>krompirjev pire</td> <td>ca. 6 litrov</td> </tr> </table>	gosto testo za pico	ca. 4 kg	lahko testo	ca. 5 kg	krhko testo	ca. 5 kg	smetana za stepanje	ca. 6 litrov	sneg iz beljaka	ca. 45 beljakov	krompirjev pire	ca. 6 litrov
gosto testo za pico	ca. 4 kg												
lahko testo	ca. 5 kg												
krhko testo	ca. 5 kg												
smetana za stepanje	ca. 6 litrov												
sneg iz beljaka	ca. 45 beljakov												
krompirjev pire	ca. 6 litrov												
	<p>Steaker - mehčalec testa 542 890</p>												
	<p>Nastavek za mletje mesa in zelenjave R70 – komplet nožev: 542 871</p> <p>Nož 70 mm, prednož, križni nož, luknjasta ploščica 4,5 mm, vložni obroč 15 mm, potiskač.</p>												
	<p>Nastavek GOURME GVS za rezanje : 542 856</p> <p>gomoljčne zelenjave, kumaric, redkvic, čebule, krompirja, stročjega fižola, v obliki kock, mrežnega rezanja; izbira širine rezanja pommes frites in normalno rezanje na rezine. Uporablja se tudi za dekorativno rezanje, ter za rezanje čebule na kocke brez izgube soka, kar je še posebej primerno za golaže.</p>												
	<p>Sesekljalnik – Cutter CA 35 542 896</p> <ul style="list-style-type: none"> - 1400/2800 o/min - posoda 3,5 l - primeren za mešanje, sesekljanje zelenjave, mesa, rib, sadja 												

UNIVERZALNI KUHINJSKI STROJ HU 1010 - FEUMA

Stroj za predelavo sadja, zelenjave, testa in mesa

Ohišje AE 10 iz legiranega jekla s preprosto menjavo priključkov, dve pogonski hitrosti, lahka, varna uporaba, iz vseh strani pregledno in dosegljivo stikalo. Zanesljiv stroj brez rednega servisiranja.

- Za vsestransko možno uporabo.
- Visoka zmogljivost, natančno doziranje.
- Zagotavlja dobro kvaliteto predelave.
- Lahka in racionalna uporaba.
- Nerjaveče površine za enostavno čiščenje.



TEHNIČNI PODATKI	HU 1010
Vrsta toka	400 V 3~50 Hz
Vrsta zaščite	IP 54
Moč motorja	1,3/1,9 kW
Število vrtljajev gredi	160/min, 320/min
Priključni kabel s 5-polnim CEE stikalom	4,5 m
Bruto teža	33 kg
Serijska oprema	Magnetna varnostna oprema Zaščitno stikalo GS – znak CE – znak

Dimenzije

Pogonska enota AE 10

Dolžina	520 mm
Širina	400 mm
Višina	230 mm

Pogonska enota AE 10 s podvozjem

Dolžina	980 mm
Širina	770 mm
Višina	835 mm

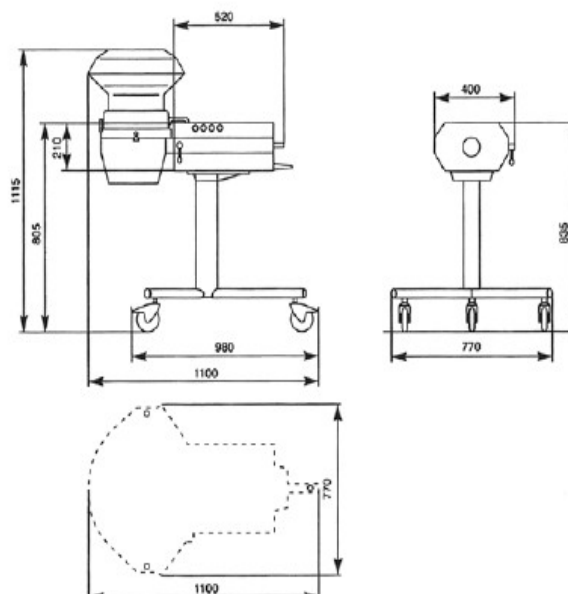



Pogonska enota AE10

Ohišje iz legiranega jekla s preprosto menjavo priključkov. Dve pogonski hitrosti. Po izklopu iz omrežja je samodejni vklop izključen. Lahka, varna uporaba, iz vseh strani pregledno in dosegljivo stikalo. Zanesljiv stroj brez rednega servisiranja.



Podstavek s ploščo za odlaganje, na kolesih FGA

Stabilna, varna cevna konstrukcija iz legiranega jekla. 3 kolesa oploščena z gumo, z blokado. Plošča za odlaganje posode in podobno.



Ohišje z nastavkom za rezanje

3 dovodi, priprava za potiskanje in čep iz legiranega jekla.

Ohišje AG-S

Z gonilom in nastavkom za priključke, snemljivi izpustni lijak iz legiranega jekla.



Ohišje z lijačnim nastavkom

Sestavljen iz lijačnega nastavka TR-S, iz legiranega jekla (s ščitnikom za roke, ki je v skladu s predpisi za preprečevanje nesreč).

Ohišje AG-S

Z gonilom in nastavkom za priključke, s snemljivim iztočnim lijakom iz legiranega jekla.

Za uporabo plošč oziroma cilindrov za predelavo večjih količin sadja in zelenjave, starega peciva, čokolade, mandeljnov, lešnikov itd.



Opornik GH



















Potreben pri uporabi lijačnega nastavka za sortiment plošč.





























Rotor RT





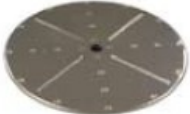



Potreben pri uporabi lijačnega nastavka za sortiment cilindrov.







REZILA IN CILINDRI HU 1010

	<p>Rezalna plošča, za rezanje zelja, čebule, kumaric, redkve. 1,0 mm debelina reza, za cca. 150 kg/h 2,0 mm debelina reza, za cca. 350 kg/h 4,0 mm debelina reza, za cca. 450 kg/h</p>	 <p>542320 542321 542322</p>    
	<p>Plošča s srpastimi noži, za rezanje mehkejših surovin, kot so paradižniki, kuhan krompir, por, čebula. 2,5 mm debelina reza, za cca. 200 kg/h 4,0 mm debelina reza, za cca. 300 kg/h 6,0 mm debelina reza, za cca. 400 kg/h</p>	<p>542325 542326 542327</p>    
	<p>Plošča za rezanje paradižnikov, 6,0 mm rez, za cca. 400 kg/h</p>	<p>542329</p>  
	<p>Plošča za ribanje surovega krompirja Fino – 3,0 mm rez, za cca. 400 kg/h Grobo – 4,0 mm rez, za cca. 400 kg/h</p>	<p>542330 542331</p> 
	<p>Plošča za ribanje sira za ribanje različnih vrst sira. Fino – 3,0 mm rez, za cca. 230 kg/h Grobo – 6,0 mm rez, za cca. 450 kg/h</p>	<p>542335 542336</p>  

	<p>Strgalna plošča za sadje in zelenjavo 2,8 mm debelina reza, za cca. 230 kg/h 3,0 mm debelina reza, za cca. 230 kg/h 3,5 mm debelina reza, za cca. 370 kg/h 4,0 mm debelina reza, za cca. 370 kg/h</p>	<p>542342 542340 542343 542341</p>  
	<p>Plošča za rezanje vseh gomoljev, kot so korenje, redkev, koleraba, zelena, krompir, repa, itd. 5,0 mm debelina reza za cca. 450 kg/h 6,0 mm debelina reza za cca. 450 kg/h 7,0 mm debelina reza za cca. 450 kg/h 9,0 mm debelina reza za cca. 450 kg/h</p>	<p>542345 542346 542347 542348</p>  
	<p>Plošča za rezanje trakov : surove ali kuhano korenje, pesa,... 4,0 mm debelina reza za cca. 250 kg/h</p>	<p>542355</p>   
	<p>Srpasti nož za rezanje kumaric, paprike, pomaranč, paradižnika, šampinjonov, gomoljev, itd. 2,5 mm debelina reza za cca. 200 kg/h 4,0 mm debelina reza za cca. 300 kg/h 6,0 mm debelina reza za cca. 400 kg/h</p>	<p>542361 542362 542363</p>    
	<p>Srpasti nož za rezanje paradižnikov z nazobčanim nožem 6,0 mm debelina reza, za cca. 350 kg/h</p>	<p>542364</p>  

	<p>Rezilna plošča za rezanje trakov za krompir, korenje, kolerabo, zeleno,...</p> <p>2,0 x 2,5 mm debelina reza, za cca. 120 kg/h 542358 3,5 x 3,5 mm debelina reza, za cca. 150 kg/h 542357 5,0 x 5,0 mm debelina reza, za cca. 200 kg/h 542350 5,0 x 7,0 mm debelina reza, za cca. 230 kg/h 542356 7,0 x 7,0 mm debelina reza, za cca. 230 kg/h 542351 7,0 x 10,0 mm debelina reza, za cca. 230 kg/h 542352</p>	
	<p>Plošča z nastavljivim nožem za fino in grobo rezanje zelja, zeli, kumaric, čebule; z rezilom, ki je nastavljivo po 0,5 mm. 0-8 mm, debelina reza, za cca. 200 - 450 kg/h - z nazobčanim nožem</p>	<p>542315 542316</p> 
	<p>Plošča za rezanje zelene 2,75 mm debelina reza, za cca. 80 kg/h</p>	<p>542337</p>
 	<p>Nož za kockasto rezanje - WSE Sestavljen iz kockaste mreže, nožev za pripravo kock in naprave za čiščenje nožev. 8 x 8 x 10 mm, za cca. 300 kg/h 542219 10 x 10 x 10 mm, za cca. 300 kg/h 542132 16 x 16 x 10 mm, za cca. 300 kg/h 542231 20 x 20 x 10 mm, za cca. 300 kg/h 542232</p>	
	<p>Cilinder za pasiranje in tlačenje krompirja za pripravo juh, omak, čokoladnih mas, pire krompirja, jabolčne čežane, itd. 1,0 mm premera odprtine, za cca. 250 kg/h 542140 1,5 mm premera odprtine, za cca. 300 kg/h 542540 2,0 mm premera odprtine, za cca. 350 kg/h 542541 3,0 mm premera odprtine, za cca. 500 kg/h 542542</p>	

	<p>Strgalni cilinder za fino drobljenje suhenga kruha, starega peciva, lešnikov, mandeljnov, kuhanega krompirja, različnih vrst sadja in zelenjave</p> <table border="0"> <tr> <td>1,5 mm debelina reza, za cca. 1.150 kg/h</td> <td>542526</td> </tr> <tr> <td>2,8 mm debelina reza, za cca. 350 kg/h</td> <td>542135</td> </tr> <tr> <td>3,5 mm debelina reza, za cca. 500 kg/h</td> <td>542136</td> </tr> <tr> <td>5,0 mm debelina reza, za cca. 800 kg/h</td> <td>542137</td> </tr> <tr> <td>7,0 mm debelina reza, za cca. 1.000 kg/h</td> <td>542138</td> </tr> <tr> <td>10,0 mm debelina reza, za cca. 1.000 kg/h</td> <td>542143</td> </tr> </table> 	1,5 mm debelina reza, za cca. 1.150 kg/h	542526	2,8 mm debelina reza, za cca. 350 kg/h	542135	3,5 mm debelina reza, za cca. 500 kg/h	542136	5,0 mm debelina reza, za cca. 800 kg/h	542137	7,0 mm debelina reza, za cca. 1.000 kg/h	542138	10,0 mm debelina reza, za cca. 1.000 kg/h	542143
1,5 mm debelina reza, za cca. 1.150 kg/h	542526												
2,8 mm debelina reza, za cca. 350 kg/h	542135												
3,5 mm debelina reza, za cca. 500 kg/h	542136												
5,0 mm debelina reza, za cca. 800 kg/h	542137												
7,0 mm debelina reza, za cca. 1.000 kg/h	542138												
10,0 mm debelina reza, za cca. 1.000 kg/h	542143												
	<p>Cilinder za ribanje sadja in zelenjave za pripravo izbranih surovih izdelkov iz različnega sadja in zelenjave, kot so gomolji, jabolka, korenje, itd.</p> <table border="0"> <tr> <td>2,8 mm debelina reza, za cca. 350 kg/h</td> <td>542520</td> </tr> <tr> <td>3,5 mm debelina reza, za cca. 500 kg/h</td> <td>542521</td> </tr> <tr> <td>4,0 mm debelina reza, za cca. 500 kg/h</td> <td>542522</td> </tr> </table> 	2,8 mm debelina reza, za cca. 350 kg/h	542520	3,5 mm debelina reza, za cca. 500 kg/h	542521	4,0 mm debelina reza, za cca. 500 kg/h	542522						
2,8 mm debelina reza, za cca. 350 kg/h	542520												
3,5 mm debelina reza, za cca. 500 kg/h	542521												
4,0 mm debelina reza, za cca. 500 kg/h	542522												
	<p>Cilinder za ribanje sadja in zelenjave za fino ingrobo rezane izdelke iz različnega sadja in zelenjave, kot so jabolka, kumarice, redkev, zelje, ...</p> <table border="0"> <tr> <td>5,0 mm debelina reza, za cca. 800 kg/h</td> <td>542510</td> </tr> <tr> <td>6,0 mm debelina reza, za cca. 850 kg/h</td> <td>542513</td> </tr> <tr> <td>7,0 mm debelina reza, za cca. 900 kg/h</td> <td>542511</td> </tr> <tr> <td>9,0 mm debelina reza, za cca. 950 kg/h</td> <td>542514</td> </tr> <tr> <td>10,0 mm debelina reza, za cca. 1.000 kg/h</td> <td>542512</td> </tr> <tr> <td>13,0 mm debelina reza, za cca. 1.000 kg/h</td> <td>542515</td> </tr> </table> 	5,0 mm debelina reza, za cca. 800 kg/h	542510	6,0 mm debelina reza, za cca. 850 kg/h	542513	7,0 mm debelina reza, za cca. 900 kg/h	542511	9,0 mm debelina reza, za cca. 950 kg/h	542514	10,0 mm debelina reza, za cca. 1.000 kg/h	542512	13,0 mm debelina reza, za cca. 1.000 kg/h	542515
5,0 mm debelina reza, za cca. 800 kg/h	542510												
6,0 mm debelina reza, za cca. 850 kg/h	542513												
7,0 mm debelina reza, za cca. 900 kg/h	542511												
9,0 mm debelina reza, za cca. 950 kg/h	542514												
10,0 mm debelina reza, za cca. 1.000 kg/h	542512												
13,0 mm debelina reza, za cca. 1.000 kg/h	542515												
	<p>Cilinder za fino ribanje suhenga kruha, orehovitih jedrc, mandeljnov.</p> <table border="0"> <tr> <td>2,0 mm debelina reza, za cca. 300 kg/h</td> <td>542147</td> </tr> </table> 	2,0 mm debelina reza, za cca. 300 kg/h	542147										
2,0 mm debelina reza, za cca. 300 kg/h	542147												

	<p>Cilinder za ribanje Surovega krompirja ter različnega sadja in zelenjave. 2,0 mm debelina reza, za cca. 300 kg/h 542146 3,0 mm debelina reza, za cca. 350 kg/h 542144 4,0 mm debelina reza, za cca. 500 kg/h 542145</p> 
	<p>Cilinder za ribanje sira – ojačan 3,0 mm debelina reza, za cca. 300 kg/h 542524 3,5 mm debelina reza, za cca. 310 kg/h 542523 4,0 mm debelina reza, za cca. 350 kg/h 542507 5,0 mm debelina reza, za cca. 380 kg/h 542509 7,0 mm debelina reza, za cca. 400 kg/h 542508</p> 
	<p>Cilinder za rezanje trakov 3,5 x 3,0 mm debelina reza, za cca. 400 kg/h 542543 6,0 x 5,5 mm debelina reza, za cca. 500 kg/h 542544 Cilinder za rezanje – Julienne 2,0 x 1,75 mm debelina reza, za cca. 250 kg/h 542545 2,5 x 2,0 mm debelina reza, za cca. 350 kg/h 542546</p> 
	<p>Cilinder za ribanje krompirja Za ribanje surovega krompirja , za pripravo cmokov, krompirjevih kroketov. Za cca. 450 kg/h 542139</p> 
	<p>Cilinder za mečkanje krompirja Za cca. 500 kg/h 542525</p> 



Planetarni mešalec za mešanje testa in smetane (40 l, 20 l)

Vključno metlica za mešanje, stepanje, mešalec, zaščita proti špricanju in kotel iz legiranega jekla. Maksimalna količina pre-delave cca. 25 kg za mešanje, stepanje in gneteje.

Kapacitete:

Kvašeno testo, testo za pizze in druge goste mase :	15 kg
Živila iz skute, krompirjev pire in druge srednje goste mase :	20 kg
Omake in druge tekoče mase :	30 kg
Sneg iz beljaka :	5 kg
Smetana :	8 kg



Nastavki za mešanje, stepanje in gnetenje.

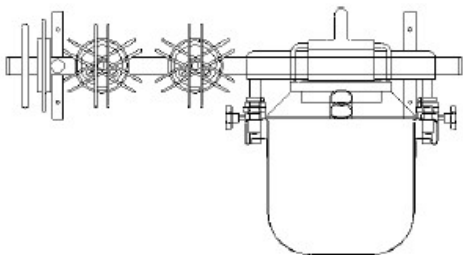

Stojalo HU WL 9

Za planetarni mešalec in stepalnik.

Za pregledno in higiensko shranjevanje in varčno izrabo porostora.



Nastavek za mletje mesa FW-SE RF

Nerjaveči rezalnik vključuje 5 rezalnikov \varnothing 82 mm (sestavljen iz predrezila, 2 križnih nožev, luknjaste plošče 13 mm, luknjaste plošče 5 mm), izvlečni kavelj in skledo.



Luknjaste plošče 2, 3, 5, 8 in 13 mm

Dodatno dobavljivo:
predrezilo, križni nož, nastavek za pripravo golaža, ploščica za pašete 3 mm.



Porcionirka PE

Polnilne plošče 80 in 100 g, za porcioniranje in oblikovanje cmokov, polpet...

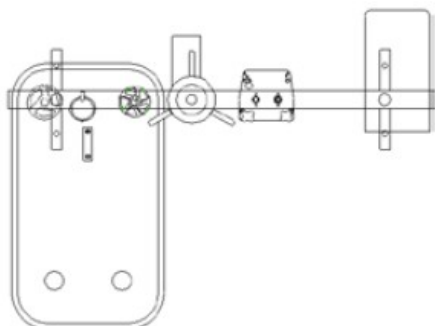

Stojalo HU WL8

Za mesoreznico, Steaker, rezalnik trakov in pribor 1000 x 550 mm vključuje gumijaste noge, uporabne tudi kot fiksna konzola.
Za pregledno higiensko shranjevanje in varčno izrabo prostora.



Mehčalec mesa – STEAKER FS
Rezalnik trakov in solate SA-StS 5 = 5 mm ali SA-StS 10 = 10 mm

Za mesoreznico Steaker, rezalnik trakov in pribor 1000 x 550 mm vključuje gumijaste noge, uporabne tudi kot fiksna konzola.

Za pregledno higiensko shranjevanje in varčno izrabo prostora.



Set rezalnih valjev

Za mehčanje mesnih rezin.

5 mm za rezanje salame, sira, zelenjave, itd.

10 mm za rezanje mesa, salame, sira, itd.



Nastavek za mletje maka



Voziček s 30 litrsko posodo

Vozna, 3 gumijasta kolesa (2 fiksna kolesa, 1 krmilno kolo), 1 blokirno kolo, snemljiva posoda iz legiranega jekla, volumen 30 l, višina ročaja 84 cm, primerna za transport različnih vrst predelanih živil.

MANJŠI UNIVERZALNI KUHINJSKI STROJI – KREFFT



NAMIZNI UNIVERZALNI KUHINJSKI STROJ KU 2-4 E

- moč: 0,8 kW
- napetost: 230 V 1~50-60 Hz
- teža: 14,5 kg
- dimenzije (všd): 450 x 360 x 260 mm
- priključek za mešanje testa in smetane R 4 z 8 litrsko posodo

Kapaciteta:

- 3 kg lahkega testa
- 3 l smetane
- 5 l majoneze
- 1,2 l beljakov



PRIKLJUČEK ZA REZANJE ZELENJAVE G 23 K

Komplet 5 nožev:

- srpast nož, nastavljiv 0 – 6 mm
- ribež RB 30, RB 50, RB 70 in K 6





MESOREZNICA W 60 N



Luknjasti nož 70 mm in komplet 3 nožev:

- prednož
- križni nož
- luknjasta ploščica R70 – 4,5 mm

	<p>R 70 N</p> <p>Mesoreznica R 70 N (ALFIX) 2 hitrosti, ohišje iz aluminija Komplet: prednož, križni nož, Luknjasta ploščica 4,5 mm in luknjast nož 70 mm; Polnjenje: 1,5 l Kapaciteta: 100 kg/h Moč: 0,6 kW, napetost: 230V 50-60 Hz, teža: 17 kg Dim.: d210 x š495 x v350 mm</p>	<p>Artikel</p> <p>540 453</p>
-------------------------------------------------------------------------------------	-----------------------------------------------------------------------------------------------------------------------------------------------------------------------------------------------------------------------------------------------------------------------------------------------------------------------------------------------------------------------------------------------------------------------------------------------------------------------------------------------	--------------------------------------

	R 70 N	Artikel
	<p>Pogonski stroj KU 2- 5 E (ALLZWECK) Zaščita motorja Moč: 0,8 kW Napetost: 230V, 50-60 Hz Teža: 14,5 kg Dim.: d 260 x š360 x v 450 mm</p>	540 108
	<p>Pogonski stroj A 2-2 (ALLFIX) 2 hitrosti; ohišje iz aluminija, moč: 0,6 kW, zaščita motorja; Napetost: 230V, 50-60 Hz Teža: 8,4 kg. Dim.: d195 x š310 x v250 mm</p>	540 206
	<p>Pogonski stroj AL 2-4 (ALLFIX) 2 hitrosti; ohišje iz aluminija, moč: 0,6 kW, zaščita motorja, Napetost: 230V, 50-60 Hz Teža: 8,4 kg Dim: d195 x š310 x v245 mm</p>	540 306
	<p>Priključek za rezanje zelenjave G 24 GR (ALLZWECK) Ohišje iz aluminija. Rezilo : nastavljivi nož 0-6 mm</p>	540 835
	<p>Priključek za rezanje zelenjave G 24 K (ALLZWECK)</p> <p>Komplet 5 nožev: * srpast nož, nastavljiv 0 - 6 mm * ribež RB 30, RB 50, RB 70 in K 6</p>	540 845
	<p>Rezila za G 24 (tudi G 22 in 23):</p> <p>Srpast nož, nastavljiv od 0-6 mm; za rezanje kumaric, zelja, krompirja, paprike...</p>	840 718
	Ribeži za ribanje korenja, sira, jabolk,	

	<p>krompirja, lešnikov, mandljev, redkvic...</p> <p>Ribež RB 15, 1,5 mm Ribež RB 23, 2,3 mm Ribež RB 30, 3,0 mm Ribež RB 50, 5,0 mm Ribež RB 70, 7,0 mm Ribež RB 90, 9,0 mm Ribež RB 120, 12,0 mm</p> <p>Ribež K 6 - za sir parmezan, lešnike, mandlje, paniranje...</p> <p>Ribež - za surov krompir</p> <p>Nož za rezanje trakov SV, 4 x (0 - 6) mm</p> <p>Nož za rezanje na rezine</p> <p>Kaseta za shranjevanje rez. plošče priključka G23 in G22.</p> <p>Kaseta za shranjevanje 5 rez. plošč priključka G 23 , G 22</p> <p>Zidna polica za 6 rez. plošč Zidna polica za 4 rez. Plošče</p>	<p>840 711 840 707 840 727 840 710 840 708 840 712 840 709</p> <p>840 713</p> <p>840 738</p> <p>840 739</p> <p>840 741</p> <p>840 737</p> <p>540 600</p> <p>541 950 541 951</p>
	<p>Mesoreznica W 60 N (ALLZWECK, ALLFIX) Luknjast nož 70 mm + komplet 3 nožev: prednož, križni nož in luknjasta ploščica R 70 - 4,5 mm</p> <p>Prednož N</p> <p>Križni nož N</p> <p>Luknjasta ploščica R 70 N – 2 2 mm Luknjasta ploščica R 70 N – 3 3 mm Luknjasta ploščica R 70 N-4,5 4,5 mm Luknjasta ploščica R 70 N - 6 6 mm Luknjasta ploščica R 70 N - 8 8 mm</p>	<p>540 665</p> <p>841 024 841 013</p> <p>841 025 841 026 841 027 841 028 841 029</p>

	<p>Pokrov</p> <p>Polnilec klobas WS 60, o 20 mm; (za W60N in R70N)</p>	<p>840 915</p> <p>840 760</p>
	<p>Priključek za rezanje zelenjave AG 3 (ALLFIX) Komplet 3 plošče: nož 21, nož 22 in nož 23</p>	<p>540 650</p>
	<p>*Rezilne plošče za AG 3:</p> <p>Ribež št. 24; o 1,5 mm, za paniranje, čokolado, lešnike, mandlje, trde vrste sira...</p> <p>Ribež št. 22; o 2,5 mm, priprava korenja in redkvic za solate...</p> <p>Ribež št. 23; o 5,0 mm, za mehke vrste sira... ! za pizze</p> <p>Ribež št. 26; o 12,0 mm</p> <p>Rez. plošča št. 25; 1,5 mm rezine</p> <p>Rez. plošča št. 27; fina za mandeljne, orehe, čokolado</p> <p>Rez. plošča št. 21; 2,5 mm rezine</p> <p>Posebna plošča K + RB Za surov krompir, cmoke</p>	<p>840 608</p> <p>840 611</p> <p>840 609</p> <p>840 610</p> <p>840 614</p> <p>840 612</p> <p>840 613</p> <p>840 616</p>



R 4 (samo za KU 2-3E in KU 2-4E)
Priključek za mešanje testa, smetane
(ALLZWECK)
z 8 l posodo iz nerjavečega jekla; za cca. 3 kg
mase.
šiba za smetano, beljak, kljuki za trdo in
mehko testo; zaščita proti pršenju SR 3.

540 825

R 2 - priključek za smetano
(ALLZWECK)
z 12 l posodo iz nerjavečega jekla in zaščito
proti pršenju SR 2 za pripravo 1,1 l snega, 2 l
smetane,
5 l majoneze, 4 l kreme , za cca 3 kg mase

540 790

KW 2-1 - priključek za testo in smetano
(ALLZWECK in ALLFIX)
z 10 l posodo iz nerjavečega jekla,
s 3 priključki: šiba, lopatka, gnetilec, za cca 2
kg mase

540 740

AP 2 N - stiskalec jagodičja
(ALLZWECK in ALLFIX)
iz nerjavečega jekla

540 775

GEM 2 - mlinček žitaric
(ALLZWECK in ALLFIX)





540 780

FM 2 - mlinček kosmičev
(ALLZWECK in ALLFIX)

540 785













	RV 6 – Priključek za cilindre	540 810
	Ohišje iz plastike	
	Cilinder za ribanje BT 6	841 217
	Za jabolka, korenje, sir, zeleno, rdečo peso, orehe,...	
	Cilinder za rezanje na rezine ST 6	841 218
	Za bučke, kumare, redkev, korenje, čebulo, krompir, zelje, peso	
	Cilinder za grobo ribanje GT 6	841 219
	Za sir, krompir, korenje, kumare, peso, bučke, jabolka, hruške,	
	Cilinder za fino ribanje FT 6	841 220
	Za sir, orehe, čokolado, drobtine	
	Cilinder za drobno ribanje TT 6	841 221
	Za zeleno, korenje, bučke	
	Cilinder za mečkanje krompirja PT 6	841 222













MOŽNE KOMBINACIJE PRIKLJUČKOV IN POGONSKIH STROJEV













attachments >		G 23	G 24	AG 3	RV 6	R 2	R 3	R 4	KW 2-1	AR 2-1	W 60	W 60 N	AW 3	FM 2	GEM 2	AP 2 N
driving units	Art.-Nr.		540835 540845	540650	540810	540790		540825	540740		540660	540665	540680	540785	540780	540775
KU 2-1		✓		✓	✓	✓			✓	✓	✓	✓	✓	✓	✓	✓
KU 2-2 E		✓		✓	✓	✓	✓	✓	✓	✓	✓	✓	✓	✓	✓	✓
KU 2-3 E		✓		✓	✓	✓	✓	✓	✓	✓	✓	✓	✓	✓	✓	✓
KU 2-4 E	540103	✓	✓	✓	✓	✓	✓	✓			✓	✓	✓	✓	✓	✓
A 2-1				✓	✓				✓	✓	✓	✓	✓	✓	✓	✓
A 2-2	540206			✓	✓				✓	✓	✓	✓	✓	✓	✓	✓
AL 2-3				✓	✓						✓	✓	✓	✓	✓	✓
AL 2-4	540306			✓	✓						✓	✓	✓	✓	✓	✓
R 70 N	540453			✓	✓						✓		✓	✓	✓	✓
R 70	540451			✓	✓							✓	✓	✓	✓	✓
PR 20		✓		✓	✓						✓	✓	✓	✓	✓	✓
PR 20-S	541553	✓	✓	✓	✓						✓	✓	✓	✓	✓	✓
PR 30/60	541580	no combination possible!														







- možna kombinacija
- možno le s predelavo pogonskega stroja po predpisih DIN EN
- pogonski stroji in priključki po ceniku

Attachment	Disks	Description	Diameter of holes	Hard ware code	Suitable for	Results
 <p>Meat mincer (540 680) AW 3</p>		Cross-shaped blade		840 805	Za razkosanje	
		Double blade		840 806	Za slanino	
		Pierced disk size 8/2	2,0 mm Ø	840 807	For minced ground meat, raw minced ground pork, sausage- and vegetable fills, etc.	
		Pierced disk size 8/3	3,0 mm Ø	840 808		
		Pierced disk size 8/4,5	4,5 mm Ø	840 809		
		Pierced disk size 8/6	6,0 mm Ø	840 819		
		Pierced disk size 8/8	8,0 mm Ø	840 810		
		Sausage stuffing device for AW 3	20 mm	540 710	Suitable for forming sausage and cevapcici	

Attachment	Disks	Description	Diameter of holes	Hard ware code	Suitable for	Results
 <p>Meat mincer (540 665) W 60 N</p>		Preparatory cutting disk N		841 024	Predpriprava mesa	
		Cross-shaped blade N		841 013	Za slanino	
		Pierced disk R 70 N – 2	2,0 mm Ø	841 025	Za mletje	
		Pierced disk R 70 N – 3	3,0 mm Ø	841 026		
		Pierced disk R 70 N – 4,5	4,5 mm Ø	841 027		
		Pierced disk R 70 N – 6	6,0 mm Ø	841 028		
		Pierced disk R 70 N – 8	8,0 mm Ø	841 029		
		Sausage stuffing device for W 60 N3	20,0 mm Ø	540 760	Klobase, čevapi	

Attachment	Disks	Description	Diameter of holes	Hard ware code	Suitable for	Results
 <p>Vegetable cutter (540 650) AG 3</p>		Rasping disk No. 24	1,5 mm Ø	840 608	Za surovo zelenjavo, lešnike, orehe, sir, krompir, čokolado, redkev	
		Rasping disk No. 22	2,5 mm Ø	840 611		
		Rasping disk No. 23	5,0 mm Ø	840 609		
		Rasping disk No. 26	12,0 mm Ø	840 610		
		Rasping disk No. 27		840 612		
		Cutting disk No. 25	1,5 mm	840 614	Kumare, korenje, krompir,...	
		Cutting disk No. 21	2,5 mm	840 613		
		Special rasping disk K + RB		840 616	Za surov krompir, za pripravo cmokov	

Attachment	Disks	Description	Diameter of holes	Hard ware code	Suitable for	Results	
 <p>Vegetable cutter (540 835)</p> <p>GR 24 G</p>		Sickle-shaped cutting disk	adjustable 0 – 6 mm	840 718	Kumare, sadje		
		Rasping disk RB 15	1,5 mm Ø	840 711	Surovo zelenjavo, korenje, lešnike, mandlje, sir, redkev, čokolada		
		Rasping disk RB 23	2,3 mm Ø	840 707			
		Rasping disk RB 30	3,0 mm Ø	840 727			
		Rasping disk RB 50	5,0 mm Ø	840 710			
		Rasping disk RB 70	7,0 mm Ø	840 708			
		Rasping disk RB 90	9,0 mm Ø	840 712			
		Rasping disk RB 120	12,0 mm Ø	840 709			
	 <p>Vegetable cutter (540 845)</p> <p>GR 24 K</p>		Crown disk K 6		840 713	Za mletje	
			Special rasping disk		840 738	Za surov krompir, cmoke	
		Strip cutting disk SV	Verstellbar 4 x 0 – 6 mm	840 739	Za surovo zelenjavo, korenje, sadje		
		Strip cutting disk fine cut	2 x 2 mm	840 741			